



photoLab[®] S6

PHOTOMETER



a xylem brand

Scope of delivery

- Photometer
- Power pack
- Product documentation

Copyright © 2016 Xylem Analytics Germany GmbH
Printed in Germany.

Overview	4
Description of the operating elements	4
Identifying the connectors	4
Selecting and calling up the menu items	5
Safety	6
Authorized use	6
General instructions	6
Labeling of notes	6
Dangers of disregarding the safety instructions	6
Qualification of the personnel	6
Technical state of the meter	7
Commissioning	8
Preparing the photometer	8
Switching on the photometer	8
Measuring the concentration	9
Measuring using cell tests	9
Zero adjustment	10
Meter Setup	12
Selecting the language	12
Setting the date/time	13
Maintenance, cleaning, disposal	14
Maintenance - Changing the lamp	14
Cleaning - Actions to take if a cell is broken	14
Disposal	15
What to do if...	16

Overview

Description of the operating elements

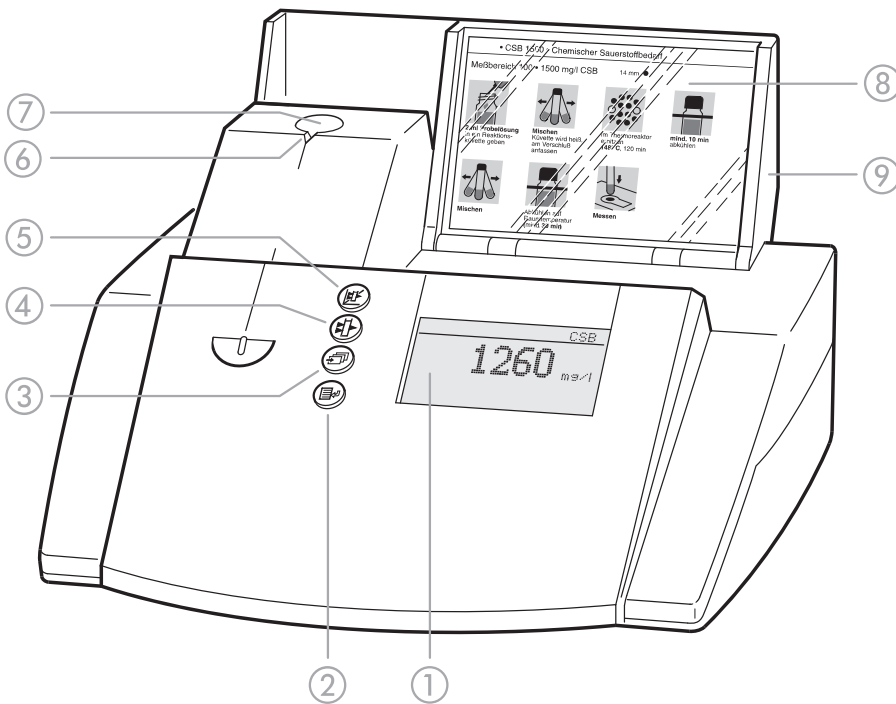

- ① Display
- ② Menu call/Enter key
- ③ Scroll key
- ④ Absorbance measurement key
- ⑤ Concentration measurement key
- ⑥ Notch for cell alignment
- ⑦ Round cell shaft
- ⑧ Storage space for analysis regulations (short form)
- ⑨ Cover with integrated on/off switch

Identifying the connectors

- ① Power pack
- ② Connection for power pack
- ③ RS 232 interface

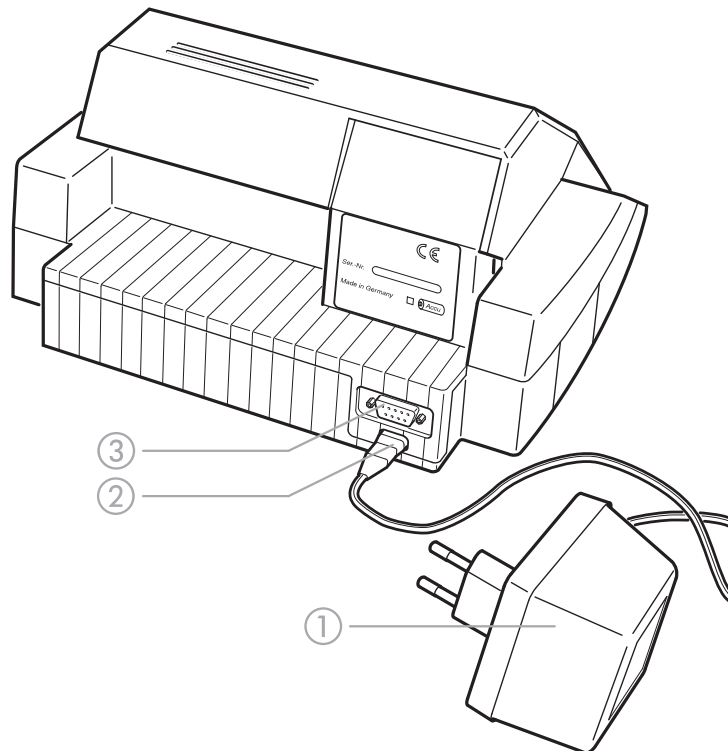

Selecting and calling up the menu items

- To switch on the photometer, open the cover.
- Press .

The following display appears:

```
Setup
└─ documentation
  method parameter
  Meter Setup
```

The following display appears:

```
Setup
  documentation
  method parameter
  └─ Meter Setup
```

```
meter setup
  return
  └─ AQA functions
    correction funct.
    adjust zero
    set date/time
```

Example:

The *documentation* menu item is preselected in the *setup* menu (▶).

Select a menu item, e. g. *meter setup*:

- Press .



The *meter setup* menu item is preselected (▶).

- Call up the *meter setup* submenu by pressing .



The required menu item is

- Select .
- Call up .

Selection lists:

- Changes to the settings are accepted after confirmation by pressing .
- Current settings are marked by "◆".
- Change to other configuration levels by
 - Selecting the menu item, *return*
 - Pressing .
- Scrolling with .

Character input:

- by using ,
- the character to be input is shown in reverse video.
- Confirm each input with .

Safety

This operating manual contains basic instructions to be followed in the commissioning, operation and maintenance of the meter. Consequently, all responsible personnel must read this operating

manual before working with the meter. The operating manual must always be available in the vicinity of the meter.

Authorized use

The photometer is authorized exclusively for analyzing substances in water and aqueous solutions using round cells or rectangular cells (special optical glass).

Observe the technical specifications of the cells according to chapter TECHNICAL DATA, in the FUNCTIONAL DESCRIPTION document [on CD-ROM]. Any other use is considered **unauthorized**.

General instructions

The photometer is constructed and tested according to the EN 61010-1 safety regulations for electronic measuring instruments. It left the factory in a safe and secure technical condition.

The smooth functioning and operational safety of the photometer can only be guaranteed under the climatic conditions specified in chapter TECHNICAL DATA, in the FUNCTIONAL DESCRIPTION document [on CD-ROM] of this operating manual.

Opening the photometer or adjustment, maintenance and repair work must only be performed by personnel authorized by the manufacturer.

The only exceptions to this are the activities described in chapter MAINTENANCE, CLEANING, DISPOSAL. Non-compliance results in the loss of warranty claims. Follow the points listed below when operating the photometer:

- Follow local safety and accident prevention regulations.
- Observe the enclosed instructions concerning reagents and accessories.
- Observe the regulations when dealing with dangerous substances.
- Follow the operating instructions at the workplace.
- Use only original spare parts.

Labeling of notes



indicates notes that you must read – for your own safety, the safety of others and to protect your meter from being damaged.



indicates notes that draw your attention to special features.

Dangers of disregarding the safety instructions

Disregarding the safety instructions can adversely affect the safety of both the user and the environment as well as the equipment.

Non-compliance with the safety instructions will result in the loss of any warranty claims.

Qualification of the personnel

The personnel responsible for the commissioning, operation and maintenance must have the necessary qualifications for this work. If the personnel do not have the required skills they have to be instructed.

Furthermore, it must be ensured that the personnel read and completely understand the present operating manual.

Technical state of the meter

It is the responsibility of the operator to continuously observe the overall technical condition (externally recognizable deficits and damage as well as alterations to the operational behavior) of the meter. If safe operation is no longer possible, the equipment must be taken out of service and secured against inadvertent operation.

Safe operation is no longer possible if

- the equipment has been damaged in transport
- the equipment has been stored under adverse conditions for a lengthy period of time
- the equipment is visibly damaged
- the equipment no longer operates as prescribed.

If you are in any doubt, please contact the supplier of the photometer.

Commissioning

The photometer operates at an environmental temperature of +5 °C to +40 °C. During transport from cold to warm surroundings, condensation can form resulting in the malfunction of the meter.

Before putting the photometer into service, wait until it has adapted to the new environmental conditions (see also chapter TECHNICAL DATA, in the FUNCTIONAL DESCRIPTION document [on CD-ROM]).

Preparing the photometer

- Place the photometer on a hard, flat surface and protect it against intensive light and heat.

Line operation

- Plug the original power pack into the socket on the photometer
- Plug the power pack into the line socket
- Switch on the photometer (open the cover).

Battery operation

- Charge the battery for approx. 5 hours before the initial commissioning. To do this:
 - Plug the original power pack into the socket on the photometer
 - Plug the power pack into the line socket and then the battery will be charged.

During battery operation or when the meter is at a standstill for longer periods of time, the battery runs down. This can result in your photometer no longer being ready for operation.

When the following symbol is displayed, charge the

battery: 

Switching on the photometer

- To switch on the photometer, open the cover. The photometer performs a check (*Self-Check*) of the entire system and then switches automatically to the *concentration* measuring mode.

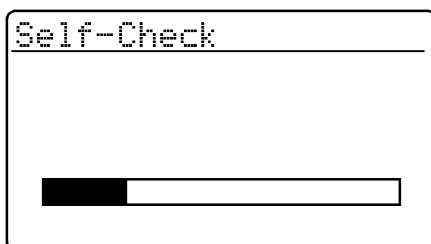

Self-check of the photometer

After approx.
5 s:

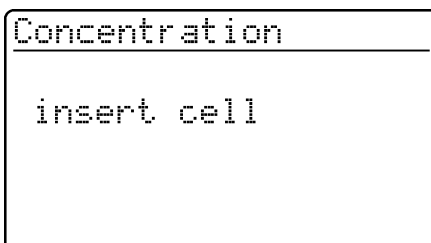

Automatic change to the measuring mode,
concentration

Measuring the concentration

- Call up the *concentration* measuring mode by actuating .

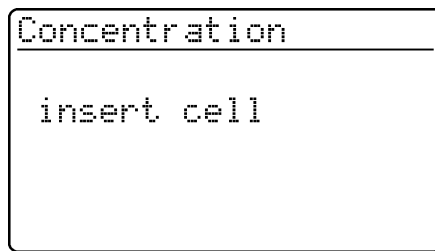

Measuring mode, *concentration*

Measuring using cell tests

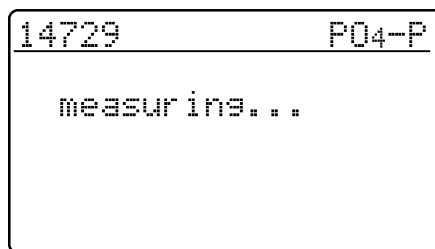
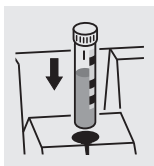

- Insert the round cell with barcode into the round cell shaft until it clicks into place. Align the line mark to the notch of the photometer.

The photometer reads the barcode of the round cell and automatically selects the relevant method.

After approx.
2 s:

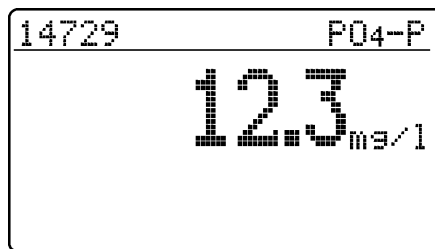

The measured value appears on the display.



If the *select method* menu is displayed, align the line mark of the round cell to the notch of the photometer.

Zero adjustment is necessary

- after changing the lamp
- after the error message, *PhotoCheck* (AQA1) occurs
- on initial commissioning
- if the photometer was mechanically stressed, e.g. percussion, transport
- if the ambient temperature changed by more than 5 °C since the last zero adjustment
- at least every six months.

When performing the zero adjustment observe the following points:

- Only use a clean, scratch-free round cell with distilled water. A prepared zero cell is provided with your photometer. In addition, a prepared zero cell is contained in the scope of delivery of the *PhotoCheck* (article 14693).
- If the round cell is visibly contaminated, or at least every 24 months, clean and refill it (minimum filling level 20 mm). Then check the cell for scratches.

Zero adjustment



Only perform the zero adjustment against distilled water in an optically perfect cell.

- Press
- In the *setup* menu, call up the *meter setup* submenu.
The following display appears:

```
meter setup
-----
return
AQA functions
correction funct.
▶adjust zero
set date/time
```

- Call up the *zero adjustment* submenu with .

```
adjust zero
-----
insert cell
```

- Insert a cell with distilled water.
The message, *measuring...*, appears on the display.

After approx.
2 s:

```
adjust zero
-----
round ok
```

Successful zero adjustment

Meter Setup

- To switch on the photometer, open the cover.
- Press 
- In the *setup* menu, call up the *meter setup* submenu.
The following display appears:

```
meter setup
-----
return
▶AQA functions
correction funct.
adjust zero
set date/time
```

This chapter describes the following functions of the *meter setup* menu:

- *select language*
- *set date/time*

Selecting the language

The following languages are stored in the photometer:

- Deutsch (German)
- English
- Français (French)
- Italiano (Italian)
- Português (Portuguese)
- Polski (Polish)
- Dansk (Danish)
- Svenska (Swedish)
- Español (Spanish)
- Nederlands (Dutch)
- Indonesia (Indonesian)
- Čeština (Czech)
- Magyar (Hungarian)
- Russkij (Russian)
- Türkçe (Turkish)
- Brasil (Brazilian)



This is the order in which the available languages appear in the *select language* menu.

The languages are listed in the language of the respective country in the photometer.



When *Russkij* is selected as the language, the Cyrillic alphabet is used for the user guidance. Method designation and ID numbers are always displayed in Latin script.

For output to the RS 232 C interface, Cyrillic characters are converted to Latin characters according to GOST.

```
meter setup
-----
correction funct.
adjust zero
set date/time
▶select language
system info
```

- Call up the *select language* menu item.

```
select language
-----
return
Deutsch
▶English
Français
Italiano
```

- Select a language, e.g. Deutsch
- Confirm with 
- Press the  key again:
Return to the *meter setup* submenu.
The displays appear in German.





Meter Setup

Setting the date/time

```
Meter Setup
-----
AQA Functions
Correction Funct.
adjust zero
▶set date/time
select language
```

- Call up the *set date/time* menu item.

```
Date/Time
-----
Date      01.01.98
          (dd.mm.yy)
Time      16:45
          (hh:mm)
↓ confirm
```

- Input the date using 
- Confirm with 
- Input the time with 
- Confirm with 

Maintenance - Changing the lamp

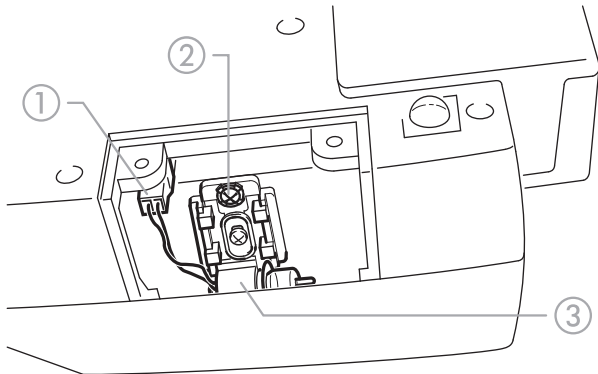

- Switch off the photometer and disconnect it from the power line
- Carefully turn up the photometer and park it safely
- Screw off the lamp cover on the underside of the photometer



Let the lamp of the photometer cool down.

- Pull out the plug ①
- Unscrew the screw ②
- Remove the lamp with its holder ③ by pulling it gently upwards



Do not touch the new light bulb of the photometer.

- Insert a new preset lamp and screw it tight using the screw ②
- Connect the plug ① of the new lamp

- Screw the lamp cover on again
- Set up the photometer again and connect it to the power line
- Press and hold
- Switch on the meter (open the cover) and after the following display appears, release

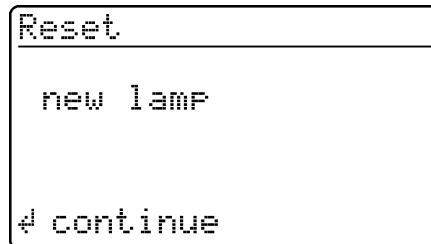

- Press
- Perform zero adjustment according to chapter ZERO ADJUSTMENT.

Cleaning - Actions to take if a cell is broken



Do not rotate the photometer to pour out the liquid!

The photometer has a draining mechanism under the cell shaft that, when operated correctly, prevents any liquid coming into contact with electronic components.

- Switch off the photometer (close the cover) and disconnect it from the line power
- Let the liquid drain off
- Carefully remove any pieces of glass, e.g. using tweezers
- Carefully clean the cell shaft with a damp, lint-free cloth
- Let the cell shaft dry

After it is dry, check the photometer:

- Perform a photometer monitoring (see section PHOTOMETER MONITORING (AQA1), in the FUNCTIONAL DESCRIPTION document [on CD-ROM]).

Disposal

Packing

The measuring instrument is sent out in a protective transport packing.

We recommend: Keep the packing material in case you have to send the measuring instrument back for service. The original packing prevents the measuring instrument from being damaged during transport.

Measuring instrument

Dispose of the measuring instrument as electronic waste at an appropriate collection point. It is illegal to dispose of it in household refuse.

Within the European Union, the batteries are removed at a specialized treatment center at the instrument's end of life. The instruments are taken to one of those specialized treatment centers via the recycling system set up for this purpose.

What to do if...

The display remains blank when switched on	Connect the photometer to the line power via the power pack. In the case of battery operation: Battery empty, charging required (approx. 5h); line operation is possible without restrictions during charging time.
 appears	Battery nearly empty. Charging required (see chapter COMMISSIONING).
Date/time is lost when switched off	The backup battery of the real time clock is empty and has to be replaced. Send the photometer to the service department for this.
Password forgotten	Inform the service department.
Photometer does not react	The connected printer is off line. Switch on the printer or pull out the interface cable.
Error messages:	
<i>remove cell</i>	The message remove cell appears on the display although no cell is inserted. Clean the cell shaft with a damp, lint-free cloth. If the error message still appears, return the photometer to the service department.
<i>lamp defective</i>	Replace the lamp (see chapter MAINTENANCE, CLEANING, DISPOSAL).
<i>no zero adjustment</i>	No zero adjustment is stored in the meter for the cell. Perform zero adjustment (see chapter ZERO ADJUSTMENT).
<i>method invalid</i>	No data is stored in the photometer for the selected method. Update method data (see chapter UPDATING METHOD DATA, in the FUNCTIONAL DESCRIPTION document [on CD-ROM]).
<i>wrong method</i>	During a difference measurement, the method was changed between the first and second measurement. During a difference measurement, the method must remain identical.
<i>E_0</i>	Hardware error: Send the photometer to the service department.
<i>E_1, E_2 or E_3</i>	Replace the lamp (see chapter MAINTENANCE, CLEANING, DISPOSAL). If the error message remains, send the meter to the service department.



What to do if...

What can Xylem do for you?

We're a global team unified in a common purpose: creating innovative solutions to meet our world's water needs. Developing new technologies that will improve the way water is used, conserved, and re-used in the future is central to our work. We move, treat, analyze, and return water to the environment, and we help people use water efficiently, in their homes, buildings, factories and farms. In more than 150 countries, we have strong, long-standing relationships with customers who know us for our powerful combination of leading product brands and applications expertise, backed by a legacy of innovation.

For more information on how Xylem can help you, go to xyleminc.com.



Service address:

Xylem Analytics Germany
Sales GmbH & Co. KG
WTW
Dr.-Karl-Slevogt-Str. 1
82362 Weilheim
Germany

Tel.: +49 881 183-325
Fax: +49 881 183-414
E-Mail wtw.rma@xyleminc.com
Internet: www.WTW.com



Xylem Analytics Germany GmbH
Dr.-Karl-Slevogt-Str. 1
82362 Weilheim
Germany