



# Turb 355 T/IR

PORTABLE TURBIDIMETER



a xylem brand

**Copyright**

© 2020, Xylem Analytics Germany GmbH  
Printed in Germany.

---

<b>1</b>	<b>Overview</b>	<b>4</b>
1.1	Display	5
1.2	Keypad	6
<b>2</b>	<b>Safety</b>	<b>7</b>
2.1	Authorized use	8
2.2	General safety instructions	8
<b>3</b>	<b>Commissioning</b>	<b>10</b>
3.1	Scope of delivery	10
3.2	Initial commissioning	10
<b>4</b>	<b>Operation</b>	<b>12</b>
4.1	Instructions for operating	12
4.1.1	Marking and indexing cuvettes	12
4.1.2	Venting the sample	14
4.2	Measuring turbidity	15
4.3	Calibration	18
4.3.1	Basic information on calibration	18
4.3.2	Calibration procedures	18
4.3.3	Preparing the calibration	19
4.3.4	Three-point calibration	20
4.3.5	Partial (user-defined) calibration	22
<b>5</b>	<b>Maintenance, cleaning, disposal</b>	<b>24</b>
5.1	Changing the batteries	24
5.2	Cleaning	26
5.2.1	Cleaning the instrument	26
5.2.2	Cleaning the cuvettes	26
5.3	Disposal	27
<b>6</b>	<b>What to do if...</b>	<b>28</b>
<b>7</b>	<b>Technical data</b>	<b>30</b>
<b>8</b>	<b>Accessories, Options</b>	<b>32</b>
<b>9</b>	<b>Lists</b>	<b>33</b>

# 1 Overview

The Turb 355 T/IR enables rapid and reliable turbidity measurements to be carried out on individual samples. The measuring method used corresponds to DIN EN ISO 7027 (Turb 355 IR) or US EPA 180.1 (Turb 355 T).

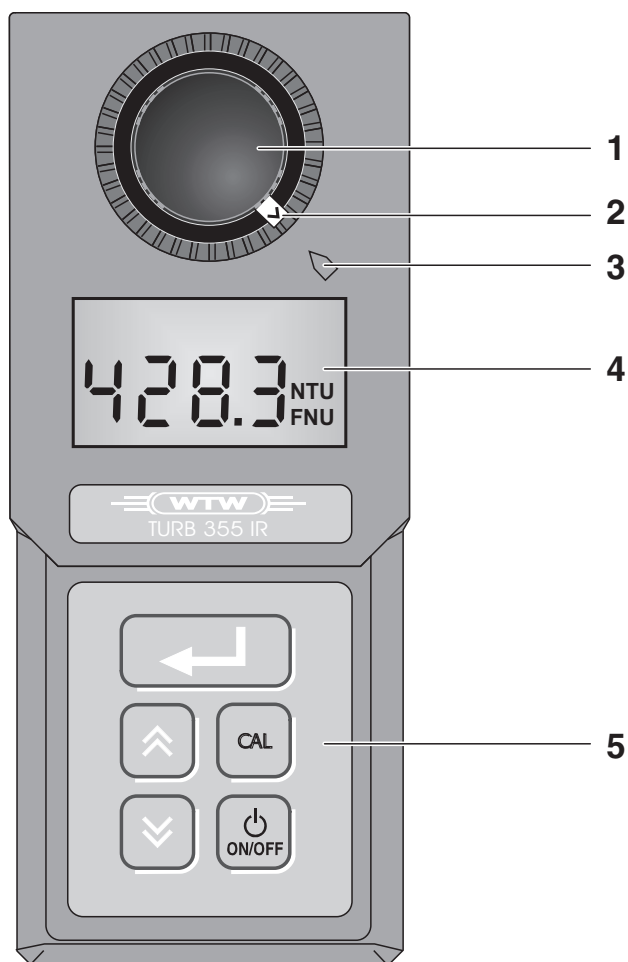

1	Cuvette in the cuvette shaft
2	Marking ring for calibration standard
3	Mark
4	Display
5	Keypad

## 1.1 Display

The LCD display has the following display elements:

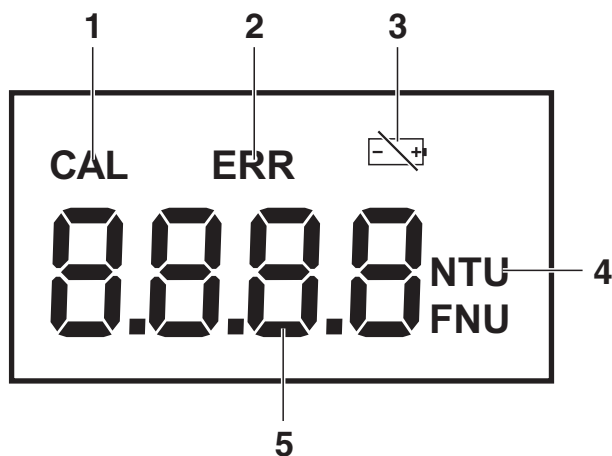





<b>1</b>	Calibration symbol - instrument in Calibration mode
<b>2</b>	Error symbol - flashes when an error occurs
<b>3</b>	Battery symbol - is illuminated if the battery needs to be changed
<b>4</b>	Measuring unit NTU or FNU
<b>5</b>	Main line

### 1.2 Keypad

The Turb 355 T/IR has a keypad with the following 5 keys:



Key	Function
	Switch measuring instrument on/off
	Select calibration standard
	
	Start measurement; press and hold: index the cell; release again: start measurement or calibration
	Call up or terminate calibration mode

## 2 Safety

This operating manual contains basic instructions that you must follow during the commissioning, operation and maintenance of the measuring instrument. Consequently, all responsible personnel must read this operating manual before working with the measuring instrument.

The operating manual must always be available within the vicinity of the measuring instrument.

### Target group

The measuring instrument was developed for measurements on site and in the laboratory. We assume that, due to their professional training and experience, operators are familiar with the safety measures that are necessary when handling chemicals.

### Symbols used



#### Caution

indicates instructions that have to be followed to prevent damage to your instrument.



#### Note

indicates notes that draw your attention to special features.



#### Note

indicates cross-references to other documents, e.g. Application reports.

## 2.1 Authorized use

Authorized use consists exclusively of the turbidity measurement of individual samples on site or in a laboratory environment.

The technical specifications given in the TECHNICAL DATA chapter must be observed. Only the operation and running of the measuring instrument according to the instructions given in this operating manual is authorized. Any other use is considered **unauthorized**.

## 2.2 General safety instructions

This instrument left the factory in a technically safe and secure condition.

### Function and operating safety

The smooth functioning and operational safety of the measuring instrument can only be guaranteed if the generally applicable safety measures and the specific safety instructions that appear in this operating manual are followed during operation.

The smooth functioning and operational safety of the measuring instrument can only be guaranteed under the climatic conditions specified in the chapter, TECHNICAL DATA.

If the instrument was transported from a cold environment to a warm environment, the formation of condensate can impair the functioning of the instrument. In this event, wait until the temperature of the instrument reaches room temperature before putting the instrument back into operation.



**Safe operation**

If safe operation is no longer possible, the instrument must be taken out of service and secured against inadvertent operation!

Safe operation is no longer possible if the measuring instrument

- has been damaged in transport
- has been stored under adverse conditions for a lengthy period of time
- is visibly damaged
- no longer operates as described in this manual.

If you are in any doubt, please contact the supplier of the instrument.

**Obligations of the operator**

The purchaser of this measuring instrument must ensure that the following laws and guidelines are observed when using dangerous substances:

- EEC directives for protective labor legislation
- National protective labor legislation
- Safety regulations
- Safety datasheets of the chemical manufacturers.

## 3 Commissioning

### 3.1 Scope of delivery

- Turb 355 IR or Turb 355 T handheld turbidimeter
- Operating manual
- 3 calibration standards (0.02 / 10.0 / 1000 NTU/FNU)
- Two empty cuvettes
- 3 marking rings
- Cleaning cloths
- Carrying case with short operating manual
- 4 alkaline manganese batteries, type AAA/Micro (in the meter)

### 3.2 Initial commissioning

#### Switching on

- 1 Switch on the turbidimeter: Press the  key for approx. one second. The instrument is immediately ready for operation.



#### Note

The meter was calibrated and tested by the manufacturer before delivery. Consequently, you can begin to measure immediately. However, we recommend to recalibrate following the initial commissioning (see section 4.3 CALIBRATION). Thus, you will quickly become familiar with the operation and calibration of the meter.

**Display when ready to measure**

After switching on or calibrating the following display indicates that the instrument is ready to measure:

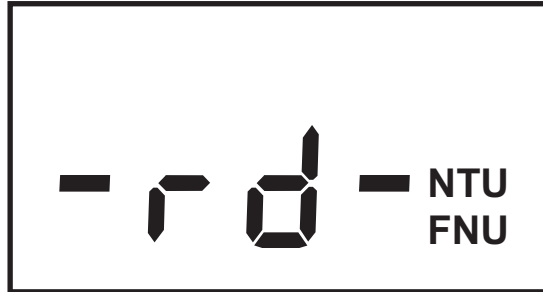

**Display during measurement**

While measuring, the instrument displays moving dashes prior to displaying a stable measured value:

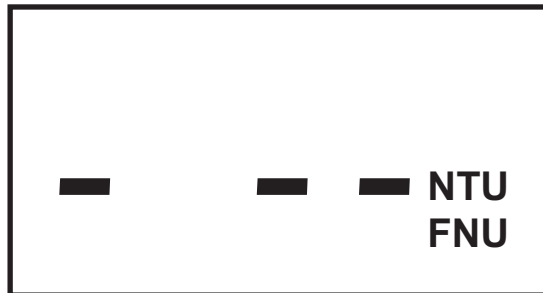

**Example of a measured value display**

After approx. 8 - 11 seconds the measured value is displayed:



**Energy saving feature**

The instrument has an energy saving feature. The energy saving feature switches off the instrument if no key is pressed for 5 minutes.

## 4 Operation

### 4.1 Instructions for operating

#### 4.1.1 Marking and indexing cuvettes

Even completely clean quality cuvettes exhibit tiny directional differences in their light transmittance. Therefore, if you want to achieve accurate and reproducible measurement results, it is necessary to always index the sample cuvettes and calibration standards in the same way (see section 2130 of the "Standard Methods for the Examination of Water and Wastewater", 19th edition).



#### Note

Never apply oily liquids (or so-called "special silicone oils") in order to "smooth" possible scratches. They would unnecessarily soil the meter and your working environment. The measurement accuracy is ensured by aligning the cuvettes. Scratched cuvettes have to be replaced.

#### Cleaning the cuvette

The cuvette must be absolutely clean (see section 5.2.2 CLEANING THE CUVETTES).

#### Indexing the sample cuvette

A sample cuvette with screwable light protection cap is indexed during measurement (see section 4.2 MEASURING TURBIDITY).

#### Marking calibration standards

Calibration standards with a permanently fixed light protection cap can be permanently marked using the marking rings provided. A marked calibration standard can be quickly brought into the optimum position. For this purpose, the marking rings have an arrow that is turned towards the mark on the light shaft. This shortens the entire calibration procedure.

Mark a calibration standard as follows:

- 1 | Switch on the turbidimeter: Press the  key.

- 2 | Make sure that the outside of the cuvette is clean, dry, and free of fingerprints.
- 3 | Insert the calibration standard in the cuvette shaft so that it clicks into place.
- 4 | Slowly rotate the calibration standard by one complete rotation (by 360 °) in small steps and hold the  key depressed while doing so. After each step, wait for a moment until the display is stable. Watch the display of the turbidimeter while you rotate the cuvette. Subsequently, turn the calibration standard to the position with the lowest displayed value.



**Note**

To keep the drift as low as possible, the time for indexing the cuvette while pressing and holding the  key is limited to 30 or 60 seconds. After this time the turbidimeter automatically starts the measurement or calibration.

- 5 | With the cuvette in this position, place a marking ring on the calibration standard so that the arrow on the marking ring points to the mark on the enclosure.
- 6 | Leave the marking ring on the light protection cap of the calibration standard. This calibration standard is now marked permanently.

### Indexing a calibration standard during calibration

A marked calibration standard is indexed as follows:

1	Insert the marked calibration standard in the cuvette shaft so that it clicks into place.
2	Turn the calibration standard so that the arrow on the marking ring points to the mark on the enclosure.
3	While pressing and holding the  key, slowly align the calibration standard in the range around the arrow, i.e. turn it in small steps. After each step, wait for a moment until the display is stable. Subsequently, turn the calibration standard to the position with the lowest displayed value.
4	Leave go of the  key.

#### 4.1.2 Venting the sample

Air bubbles in the sample affect the measuring result to a massive extent because they have an extensive scattering effect on the incident light. Larger air bubbles cause sudden changes in the measured values whereas smaller air bubbles are recorded by the instrument as turbidity. Therefore, avoid or remove air bubbles:

#### Avoiding or removing air bubbles

- During sampling, ensure all movement is kept to a minimum
- If necessary, vent the sample (ultrasonic baths, heating or adding a surface-active substance to reduce surface tension)

## 4.2 Measuring turbidity



### Caution

Never pour liquid directly into the cuvette shaft. Always use a cuvette for the measurement. The measuring instrument only measures precisely when the cuvette is closed with the black light protective cap (WTW cuvettes).





### Note

The outside of the cuvette always has to be clean, dry, and free of fingerprints. Clean the cuvette before starting to measure (see section 5.2.2 CLEANING THE CUVETTES). Only hold the cuvettes by the top or by the black light protection cap.

### Measuring

This is how to measure the turbidity of a sample using the Turb 355 T/IR:

1	Switch on the turbidimeter: Press the  key.
2	Rinse out a clean cuvette with the sample to be measured: Pour approximately 10 ml sample into the cuvette. Close the cuvette and rotate it several times before throwing the sample away.
3	Repeat the rinsing procedure twice more.
4	Fill the cuvette with the sample to be measured (approx. 15 ml). Close the cuvette with the black light protection cap.

- 5 Make sure that the outside of the cuvette is clean, dry, and free of fingerprints.
- 6 Insert the cuvette in the cuvette shaft so that it clicks into place.
- 7 Align the cuvette:  
Slowly rotate the cuvette by one complete rotation (by 360 °) in small steps and hold the  key depressed while doing so. After each step, wait for a moment until the display is stable. Watch the display of the turbidimeter while you rotate the cuvette. Subsequently, turn the cuvette to the position with the lowest displayed value.



**Note**

To keep the drift as low as possible, the time for indexing the cuvette while pressing and holding the  key is limited to 30 or 60 seconds. After this time the turbidimeter automatically starts the measurement or calibration.

- 8 Leave go of the  key.
- 9 Dashes are displayed while the measured value is being determined.
- 10 Read the measured value when it is displayed.





- 11 Repeat steps 2 to 9 for further samples.

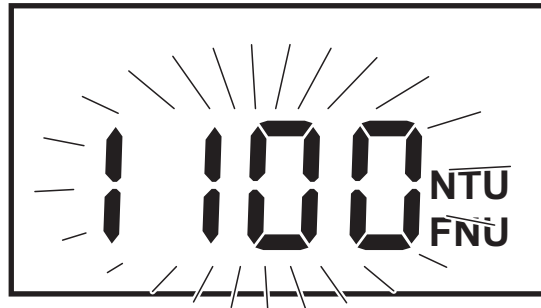

**Display when  
measuring range is  
exceeded**

If the measured value is outside the measuring range of the Turb 355 T/IR, *1100* flashes on the display:

**Switching the meter  
on/off**

To switch the meter off, press the  key.

### 4.3 Calibration

#### 4.3.1 Basic information on calibration

**Why calibrate?**

Just like any other measuring instrument, the measuring accuracy of the Turb 355 T/IR has to be checked and adjusted at regular intervals.

**When to calibrate?**

Under normal conditions, we recommend calibrating the turbidimeter at least every three months.

#### 4.3.2 Calibration procedures

You have the following possibilities for calibrating the Turb 355 T/IR:

- Three-point calibration over the entire measuring range according to the specified calibration program (section 4.3.4).
- Partial (user-defined) calibration over a limited range (section 4.3.5).
- Single-point calibration. This is a special user-defined calibration and only recommended as a temporary solution. After a single-point calibration, measuring is only possible close to the calibration point and with reduced accuracy.

**Calibration points and measuring ranges**

For optimum calibration over the entire measuring range of the instrument, you will require the following three calibration standards:

Standard no.	NTU/FNU
1	1000
2	10.0
3	0.02

The calibration can also be performed with less than the three calibration standards if the anticipated measured

values lie in a limited range (partial calibration). However, when selecting the calibration points, the following rules must be followed so that the instrument measures with the precision specified in chapter 7 TECHNICAL DATA within the calibration period:

- The expected measuring range must lie between two calibration points.
- If there are more possible calibration points between the start and end of the calibration interval, they must be used.

### 4.3.3 Preparing the calibration

Perform the following preparatory activities when you want to calibrate:

- |   |                                                                                                                     |
|---|---------------------------------------------------------------------------------------------------------------------|
| 1 | Have the required calibration standards ready and mark them as necessary (see 4.1.1 MARKING AND INDEXING CUVETTES). |
| 2 | Make sure that the outsides of the cuvettes are clean, dry, and free of fingerprints.                               |



#### Caution

Never open the cuvettes containing the calibration standards.

**Calibration  
sequence****4.3.4 Three-point calibration**



The three-point calibration according to the calibration program calibrates the instrument using the calibration standards in the following order:

1000 > 10.0 > 0.02 NTU/FNU



**Note**

If, after the end of a calibration step, you do not resume the calibration within 5 minutes, the instrument automatically switches itself off. The data calibrated up to this point remain stored and will be used.

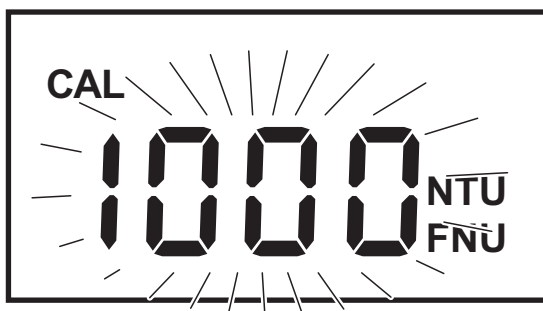

To calibrate your measuring instrument using the calibration program, proceed as follows:

- 1 Switch on the turbidimeter: Press the  key.
- 2 Press the  key. CAL and a flashing 1000 appear on the display. This indicates that you should insert the 1000 NTU/FNU calibration standard.



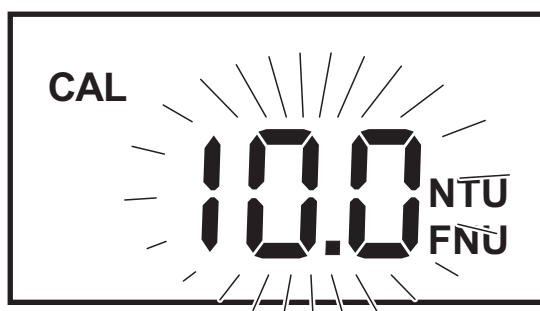

- 3 Insert the 1000 NTU/FNU calibration standard in the cuvette shaft so that it clicks into place.
- 4 Press the  key and align the cuvette as described on page 12.  
After releasing the  key a 30 seconds countdown is displayed. The instrument measures the calibration standard and afterwards shortly displays the 1000. Then the prompt to insert the second calibration standard is displayed:



- 5 Insert the 10.0 NTU/FNU calibration standard in the cuvette shaft so that it clicks into place.
- 6 Press the  key and align the cuvette as described on page 12.  
After releasing the  key a 60 seconds countdown is displayed. The instrument measures the calibration standard and afterwards shortly displays the 10.0. Then the prompt to insert the third calibration standard is displayed:



- 7 | Insert the 0.02 NTU/FNU calibration standard in the cuvette shaft so that it clicks into place.
- 8 | Press the  key and align the cuvette as described on page 12. After releasing the  key a 30 seconds countdown is displayed. The instrument measures the calibration standard and afterwards shortly displays the 0.02. Then the instrument returns to the measuring mode:

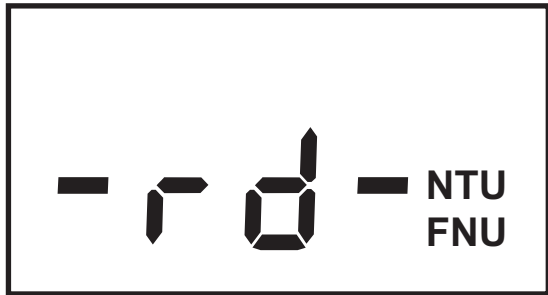



**Terminating the calibration prematurely**





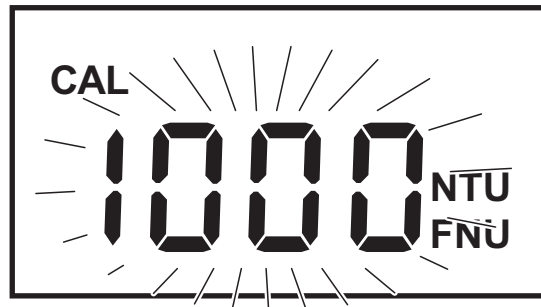

When you want to terminate the calibration prematurely after a calibration step is finished press the  key. The instrument returns to the measuring mode. The instrument stores the data calibrated up to this point and will use them for future measurements.

**4.3.5 Partial (user-defined) calibration**

You can also calibrate the instrument using two or only one calibration standard. When doing so, please follow the notes in 4.3.2 CALIBRATION PROCEDURES.

- 1 | Switch on the turbidimeter: Press the  key.
- 2 | Press the  key. CAL and a flashing 1000 appear on the display. This indicates that you should insert the 1000 NTU/FNU calibration standard.



3	If required, select another calibration standard (10.0 or 0.02 NTU/FNU) with the  or  key.
4	Insert the selected (flashing) calibration standard in the cuvette shaft so that it clicks into place.
5	Press the  key and align the cuvette as described on page 12. After releasing the  key a 30 or 60 seconds countdown is displayed. The instrument measures the calibration standard and afterwards shortly displays the nominal value of the calibration standard. Then the prompt to insert the next lower calibration standard is displayed.
6	If required, select another calibration standard with the  or  key (the display of the respective calibration standard flashes).
7	Repeat steps 4 to 6 until all required calibration standards have been measured.



### Note

After calibration with the 0.02 NTU/FNU calibration standard, the instrument automatically terminates the calibration program and returns to the measuring mode.

### Terminating the calibration

When you want to terminate the calibration after a calibration step is finished press the  key. The instrument returns to the measuring mode. The instrument stores the data calibrated up to this point and will use them for future measurements.

## 5 Maintenance, cleaning, disposal

### 5.1 Changing the batteries

#### Battery symbol flashes

The batteries must soon be changed if the battery symbol  flashes on the display:

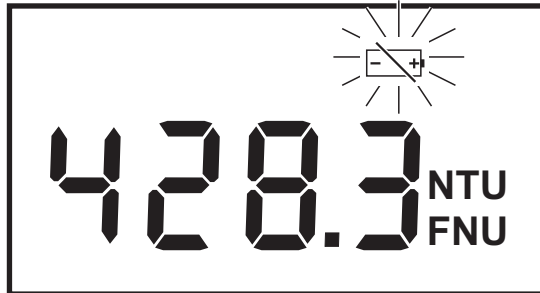

The batteries are nearly empty and should soon be exchanged. The instrument still measures with the specified accuracy.

#### Battery symbol permanently illuminated

A battery exchange is immediately necessary when the battery symbol  is displayed permanently:

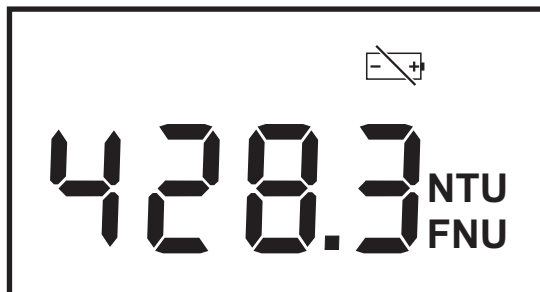

In this case, change the batteries immediately. The instrument might no longer measure with the specified accuracy. If the batteries are too weak to measure, the turbidimeter switches itself off. It can only be switched on again when the batteries have been replaced.



## Battery replacement

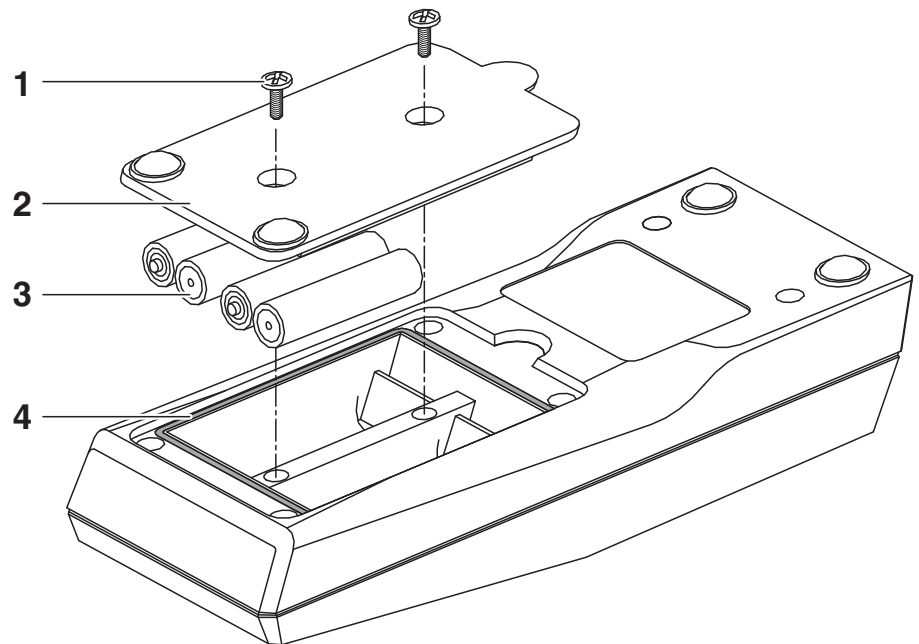

1	Switch off the turbidimeter: Press the  key.
2	Place the instrument with the operating panel face down on a soft surface.
3	Undo the two screws (1).
4	Open the lid of the battery compartment (2).
5	Remove the old batteries from the battery compartment.
6	Insert new batteries (3). While doing so, check that the poles are correct according to the diagram in the battery compartment.
7	Replace the lid of the battery compartment.
8	Attach the lid with the two screws. At the same time, make sure that the sealing gasket around the battery compartment (4) forms a tight seal with the lid.

## 5.2 Cleaning

### 5.2.1 Cleaning the instrument

Occasionally wipe the outside of the instrument with a damp, lint-free cloth. Disinfect the housing with isopropanol as required.



#### Caution

Avoid contact with acetone or similar detergents that contain solvents as these can damage the housing. Remove any splashes immediately.

### 5.2.2 Cleaning the cuvettes

Cuvettes used for measuring turbidity must be clean, dry and free of fingerprints. Therefore, clean them regularly:

1	Clean the cuvettes inside and out with hydrochloric acid or laboratory soap.
2	Rinse out several times with distilled water.
3	Let them dry in the air.
4	Only hold the cuvettes by the top or by the light protection cap so that the optical path is not impaired.

### 5.3 Disposal

#### **Packing**

This measuring instrument is sent out in protective transport packing material.

We recommend keeping the packing material in case you have to send the instrument back for service.

The original packing prevents the instrument from being damaged during transport.

#### **Measuring instrument**

To finally dispose of the instrument, take it to a collection point responsible for electronic waste. It is illegal to dispose of the measuring instrument as household refuse.

#### **Calibration standards**

Used calibration standards can be disposed of as household refuse.

## 6 What to do if...

**Flashing 100 display**

Cause	Remedy
– Measuring range exceeded	– This cannot be remedied. Sample is not suitable for the measurement

**Measured values that are obviously too high**

Cause	Remedy
– Cuvette contaminated	– Clean the cuvette
– Cuvette scratched	– Replace the cuvette
– Cuvette misted up	– Adjust the temperature of the sample before measuring
– Air bubbles in the cuvette	– Remove air bubbles
– Measuring instrument not correctly calibrated	– Calibrate the instrument

**Error message *ERR***



Cause	Remedy
– Internal error	– Have the instrument repaired by the WTW service department

**Error message**  
***ERR* and *CAL* are**  
**displayed**

**Cause**

- Error during calibration:  
The standard used is  
incorrect or too old

**Remedy**

- Check that you have used  
the correct standards and  
whether the standards are  
not too old. If necessary,  
repeat calibration
- Restore the factory  
calibration:  
Press and hold the  key,  
now press the  key.  
Then release both keys.  
The meter switches itself  
off when completed. When  
the meter is turned on  
again, *ERR* will no longer  
be displayed.  
The meter may operate  
with reduced accuracy

**Note**

If a fault cannot be remedied, send the instrument to WTW.

## 7 Technical data

<b>Measuring principle</b>	Turb 355 IR	Nephelometric acc. to DIN EN ISO 7027
	Turb 355 T	Nephelometric according to US EPA 180.1
<b>Light source</b>	Turb 355 IR	Infrared LED
	Turb 355 T	White light tungsten lamp
<b>Measuring range</b>	0.01 - 1100 NTU/FNU	
<b>Resolution</b>	In the range 0.01 - 99.99 NTU/ FNU	0.01 NTU/FNU
	In the range 100.0 - 999.9 NTU/FNU	0.1 NTU/FNU
	In the range 1000 - 1100 NTU/FNU	1 NTU/FNU
<b>Accuracy (± 1 digit)</b>	In the range 0 - 500 NTU/FNU	± 2 % of the measured value or ± 0,1 NTU/FNU
	In the range 500 - 1100 NTU/FNU	± 3 % of the measured value
<b>Response time</b>	14 seconds	
<b>Calibration</b>	Automatic 3-point calibration or partial (user-defined) calibration	

<b>Ambient temperature</b>	Storage	- 25 °C ... + 65 °C
	Operation	0 °C ... + 50 °C
<b>Sample temperature</b>	0 °C - 50 °C	
<b>Power supply</b>	Batteries	4 x alkali-manganese, size AAA/Micro
	Lifetime	Approx. 5000 measurements
<b>Dimensions of hand-held turbidimeter</b>	Length	165 mm
	Width	70 mm
	Height	48 mm
<b>Set carrying case</b>	Depth	213 mm
	Width	257 mm
	Height	60 mm
<b>Total weight of set</b>	1.22 kg	
<b>Test certificates</b>	CE	

## 8 Accessories, Options

Description	Model	Order no.
Set of calibration standards for Turb 355 T/IR 0.02 / 10.0 / 1000 NTU/ FNU	Kal. Kit P Turb 355 IR/T	600 547
Set of empty cuvettes (3 pieces) for Turb 350/355 IR or Turb 355 T	Cell Turb 350/SET	600 606



## 9 Lists

This chapter provides additional information and orientation aids.

### **Abbreviations**

The list of abbreviations explains the abbreviations that appear on the display or when dealing with the instrument.

### **Index**

The index will help you to find the topics that you are looking for.

**Abbreviations**

Cal	Calibration
ERR	Error message (see chapter 6 WHAT TO DO IF...)
FNU	Formazine nephelometric unit
LCD	Liquid Crystal Display
NTU	Nephelometric turbidity units
-rd-	Read Calibration step active

**Index****A**

Air .....	14
Aligning and marking a cell .....	12
Authorized use .....	8

**B**

Batteries .....	24
Battery symbol .....	24

**C**

Calibrating	
when? .....	18
why? .....	18
Calibration	
partial (user-defined) .....	18
single point .....	18
terminate .....	23
terminating prematurely .....	22
three-point .....	18
Calibration points and measuring	
ranges .....	18
Calibration program .....	20
Calibration standards .....	18
Changing the batteries .....	24
Checking the measuring accuracy ..	18
Cleaning agent .....	26
Copyright .....	2

**D**

Display elements .....	5
------------------------	---

**E**

Energy saving feature .....	11
Error messages .....	28
Error symbol .....	5

**I**

Indexing	
----------	--

calibration standard .....	14
sample cuvette .....	12
Initial commissioning .....	10

**K**

Keys .....	6
------------	---

**L**

LCD Display .....	5
-------------------	---

**M**

Marking a standard cuvette .....	12
Measuring range exceeded .....	17, 28
Measuring unit .....	5

**O**

Obligations of the operator .....	9
Operating safety .....	8
Options .....	32

**R**

Readiness to measure .....	11
----------------------------	----

**S**

Safe operation .....	9
Safety measures .....	7
Sequence of the calibration .....	20

**T**

Target group .....	7
--------------------	---





# What can Xylem do for you?

We're a global team unified in a common purpose: creating innovative solutions to meet our world's water needs. Developing new technologies that will improve the way water is used, conserved, and re-used in the future is central to our work. We move, treat, analyze, and return water to the environment, and we help people use water efficiently, in their homes, buildings, factories and farms. In more than 150 countries, we have strong, long-standing relationships with customers who know us for our powerful combination of leading product brands and applications expertise, backed by a legacy of innovation.

**For more information on how Xylem can help you, go to [xylem.com](http://xylem.com).**



## **Service and Returns:**

Xylem Analytics Germany  
Sales GmbH & Co. KG  
WTW  
Dr.-Karl-Slevogt-Str. 1  
82362 Weilheim  
Germany

Tel.: +49 881 183-325  
Fax: +49 881 183-414  
E-Mail [wtw.rma@xylem.com](mailto:wtw.rma@xylem.com)  
Internet: [www.WTW.com](http://www.WTW.com)



Xylem Analytics Germany GmbH  
Dr.-Karl-Slevogt-Str. 1  
82362 Weilheim  
Germany